



<div style="text-align: center;">  <p>ADL 奧德利® AUDLEY FP5N65</p> </div> <p>Features:</p> <ul style="list-style-type: none"> <input type="checkbox"/> Low Intrinsic Capacitances. <input type="checkbox"/> Excellent Switching Characteristics. <input type="checkbox"/> Extended Safe Operating Area. <input type="checkbox"/> Unrivalled Gate Charge :Qg=15nC (Typ.). <input type="checkbox"/> BVDSS=650V, I_D=5A <input type="checkbox"/> R_{DS(on)} : 2.3 Ω (Max) @V_G=10V <input type="checkbox"/> 100% Avalanche Tested 	<div style="text-align: right;">  </div> <p style="text-align: center; font-weight: bold;">TO-220</p> <div style="text-align: center;">  </div> <div style="text-align: center;">  </div> <div style="text-align: right; margin-top: 10px;"> <p>1.Gate (G)</p> <p>2.Drain (D)</p> <p>3.Source (S)</p> </div>
---	---

Absolute Maximum Ratings (Ta=25°C unless otherwise noted)

Symbol	Parameter	Value	Unit
V _{DSS}	Drain-Source Voltage	650	V
I _D	Drain Current	T _j =25°C	5
		T _j =100°C	2.8
V _{GS(TH)}	Gate Threshold Voltage	±30	V
E _{AS}	Single Pulse Avalanche Energy (note1)	260	mJ
I _{AR}	Avalanche Current (note2)	5	A
P _D	Power Dissipation (T _j =25°C)	120	W
T _j	Junction Temperature(Max)	150	°C
T _{stg}	Storage Temperature	-55~+150	°C
TL	Maximum lead temperature for soldering purpose, 1/8" from case for 5 seconds	300	°C

Thermal Characteristics

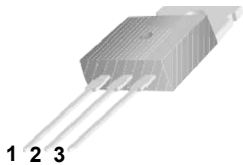
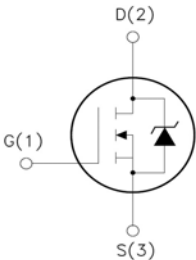
Symbol	Parameter	Typ.	Max.	Unit
R _{θJC}	Thermal Resistance, Junction to Case	-	1.18	°C/W
R _{θJA}	Thermal Resistance, Junction to Ambient	-	62.5	°C/W

Electrical Characteristics (Ta=25°C unless otherwise noted)

Symbol	Parameter	Test Condition	Min.	Typ.	Max.	Unit
Off Characteristics						
BV _{DSS}	Drain-Source Breakdown Voltage	I _D =250μA, V _{GS} =0	650	-	-	V
ΔBV _{DSS} /ΔT _J	Breakdown Voltage Temperature Coefficient	I _D =250μA, Reference to 25°C	-	0.6	-	V/°C
I _{DSS}	Zero Gate Voltage Drain Current	V _{DS} =650V, V _{GS} =0V	-	-	10	μA
		V _{DS} =480V, T _J =125°C	-	-	100	
I _{GSSF}	Gate-body leakage Current, Forward	V _{GS} =+30V, V _{DS} =0V	-	-	100	nA
I _{GSSR}	Gate-body leakage Current, Reverse	V _{GS} =-30V, V _{DS} =0V	-	-	-100	
On Characteristics						
V _{GS(TH)}	Gate Threshold Voltage	I _D =250μA, V _{DS} =V _{GS}	2	-	4	V
R _{DS(ON)}	Static Drain-Source On-Resistance	I _D =2.5A, V _{GS} =10V	-	-	2.3	Ω
Dynamic Characteristics						
C _{iss}	Input Capacitance	V _{DS} =25V, V _{GS} =0, f=1.0MHz	-	520	670	pF
C _{oss}	Output Capacitance		-	70	90	
C _{rss}	Reverse Transfer Capacitance		-	8	11	
Switching Characteristics						
T _{d(on)}	Turn-On Delay Time	V _{DD} =300V, I _D =5A R _G =25Ω (Note 3,4)	-	13	35	ns
T _r	Turn-On Rise Time		-	45	100	
T _{d(off)}	Turn-Off Delay Time		-	25	60	
T _f	Turn-Off Rise Time		-	35	80	
Q _g	Total Gate Charge	V _{DS} =480V, V _{GS} =10V, I _D =5A (Note 3,4)	-	15	20	nC
Q _{gs}	Gate-Source Charge		-	3.4	-	
Q _{gd}	Gate-Drain Charge		-	7.1	-	
Drain-Source Diode Characteristics and Maximum Ratings						
I _S	Max. Diode Forward Current	-	-	-	5	A
I _{SM}	Max. Pulsed Forward Current	-	-	-	16	
V _{SD}	Diode Forward Voltage	I _D =5A	-	-	1.35	V
T _{rr}	Reverse Recovery Time	I _S =5A, V _{GS} =0V diF/dt=100A/μs (Note3)	-	250	-	nS
Q _{rr}	Reverse Recovery Charge		-	1.5	-	μC

 Notes : 1, L=32.5mH, I_{AS}=5A, V_{DD}=50V, R_G=25Ω, Starting T_J =25°C

2, Repetitive Rating : Pulse width limited by maximum junction temperature

3, Pulse Test : Pulse Width ≤ 300μs, Duty Cycle ≤ 2%

4, Essentially Independent of Operating Temperature

Typical Characteristics

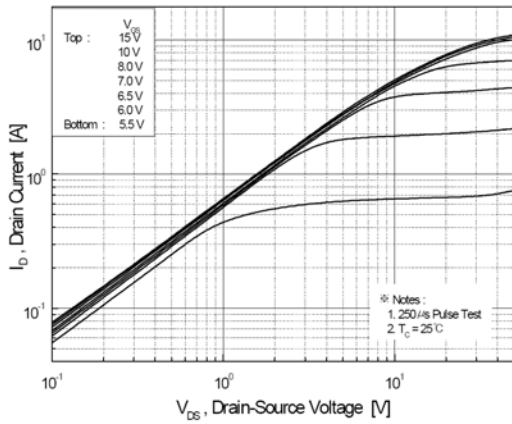

Figure 1. On-Region Characteristics

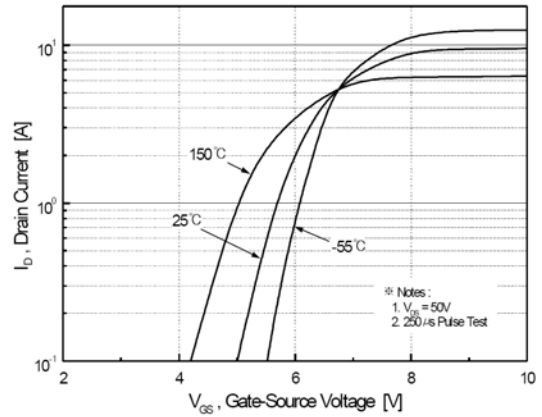

Figure 2. Transfer Characteristics

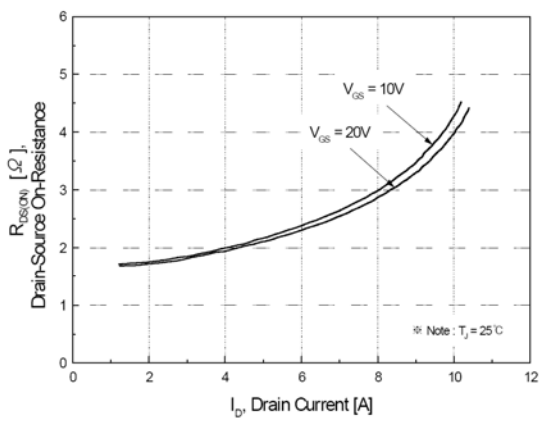

Figure 3. On-Resistance Variation vs. Drain Current and Gate Voltage

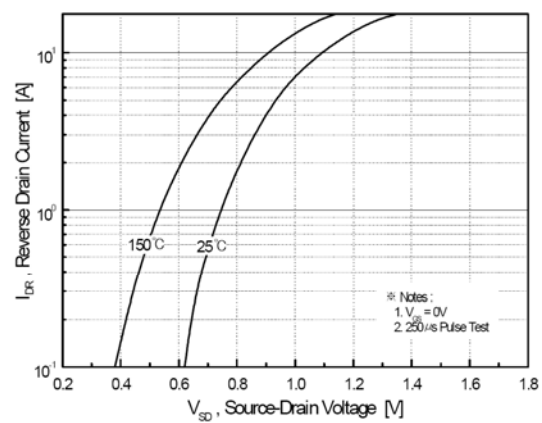

Figure 4. Body Diode Forward Voltage Variation vs. Source Current and Temperature

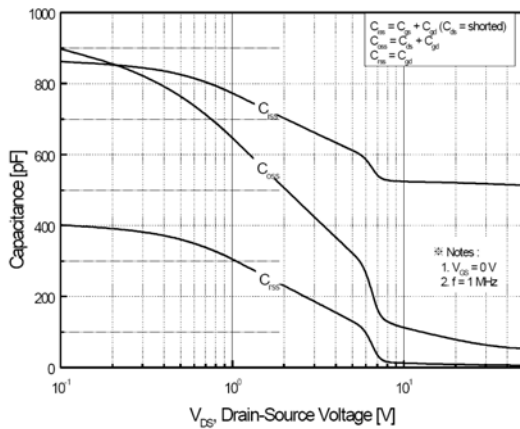

Figure 5. Capacitance Characteristics

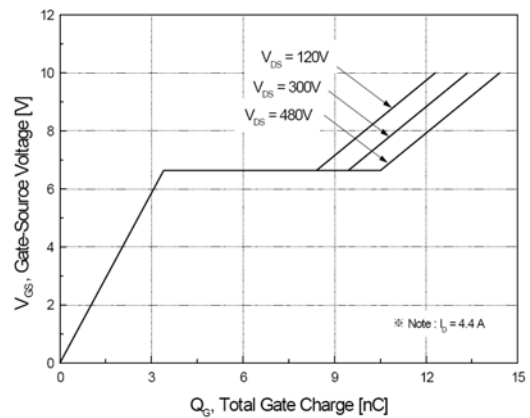

Figure 6. Gate Charge Characteristics

Typical Characteristics (Continued)

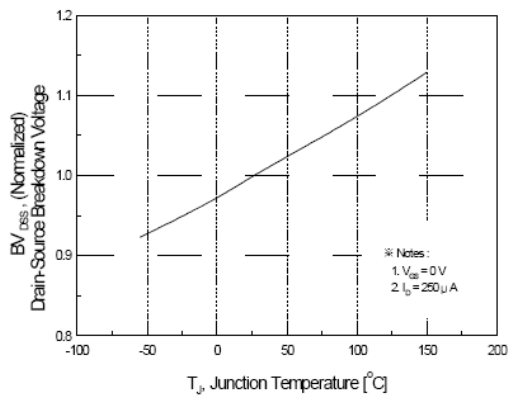

Figure 7. Breakdown Voltage Variation vs Temperature

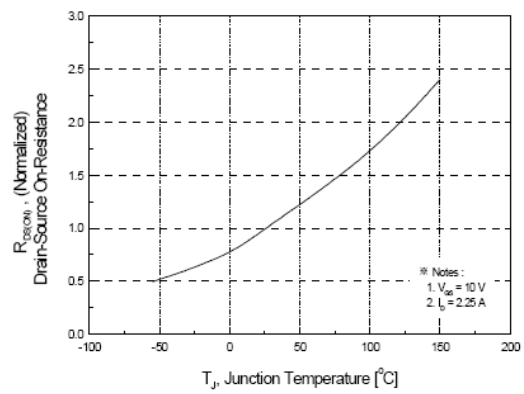

Figure 8. On-Resistance Variation vs Temperature

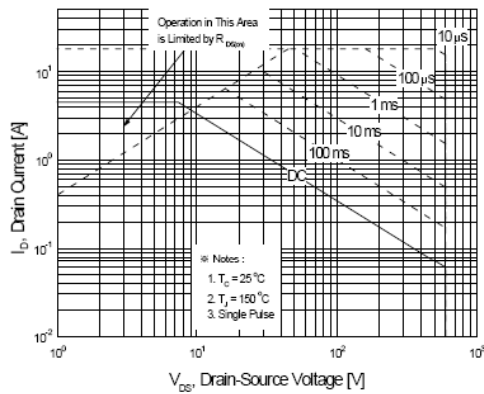

Figure 9. Maximum Safe Operating Area

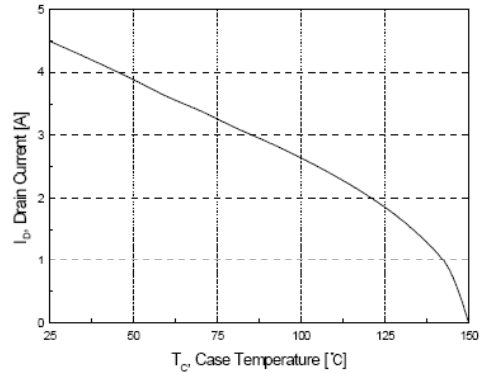

Figure 10. Maximum Drain Current vs Case Temperature

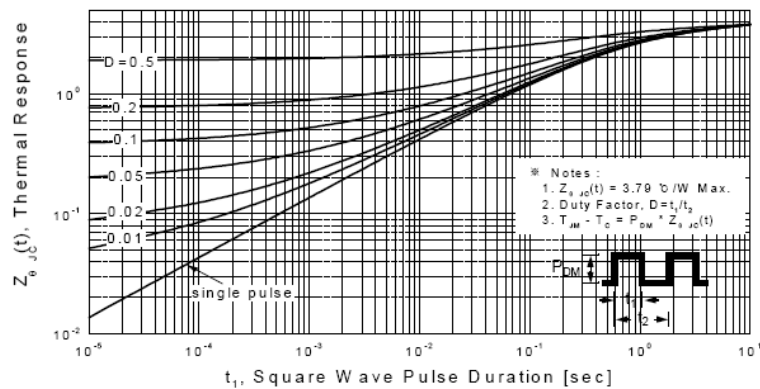
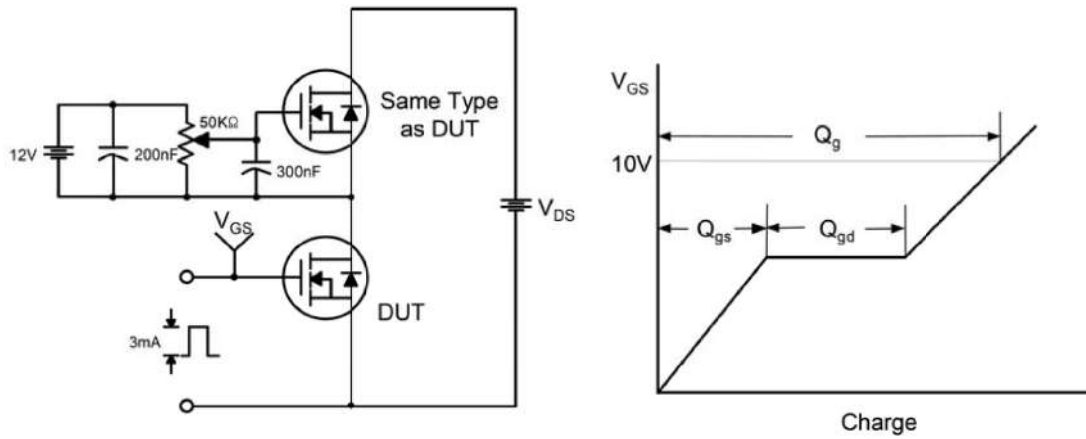
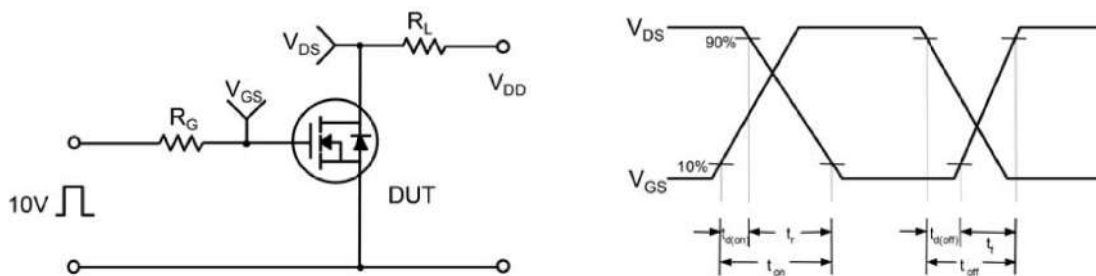

Figure 11. Transient Thermal Response Curve

Gate Charge Test Circuit & Waveform



Resistive Switching Test Circuit & Waveforms



Unclamped Inductive Switching Test Circuit & Waveforms

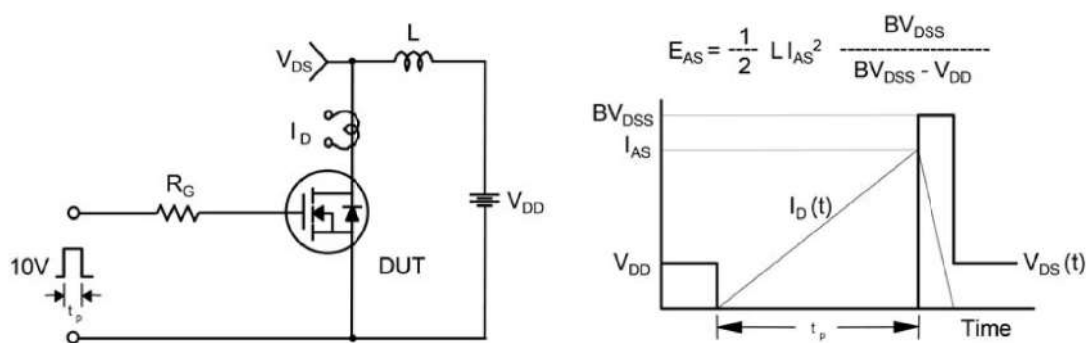

Peak Diode Recovery dv/dt Test Circuit & Waveform

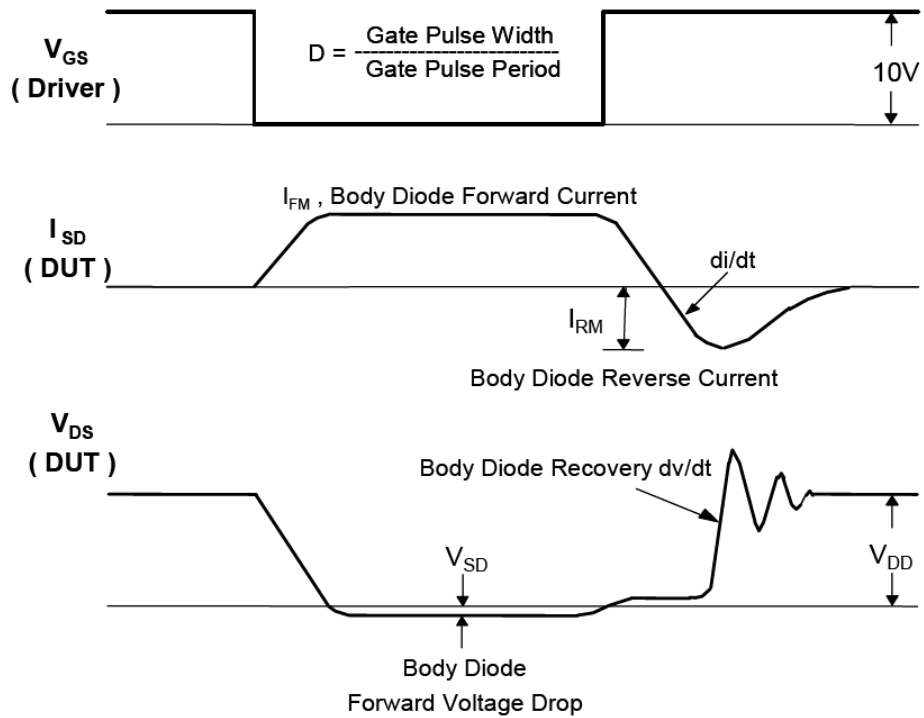
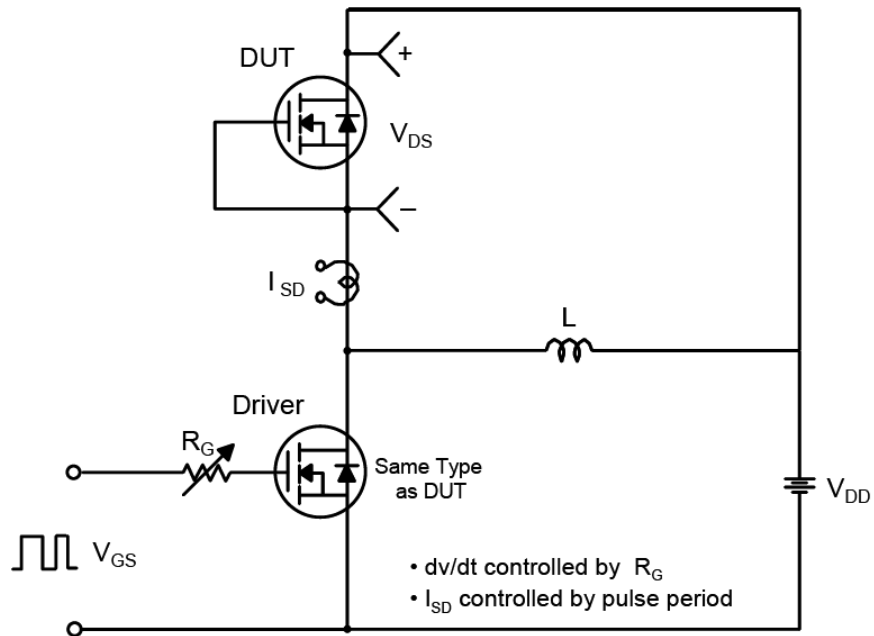

Package Dimension

TO-220

Unit: mm

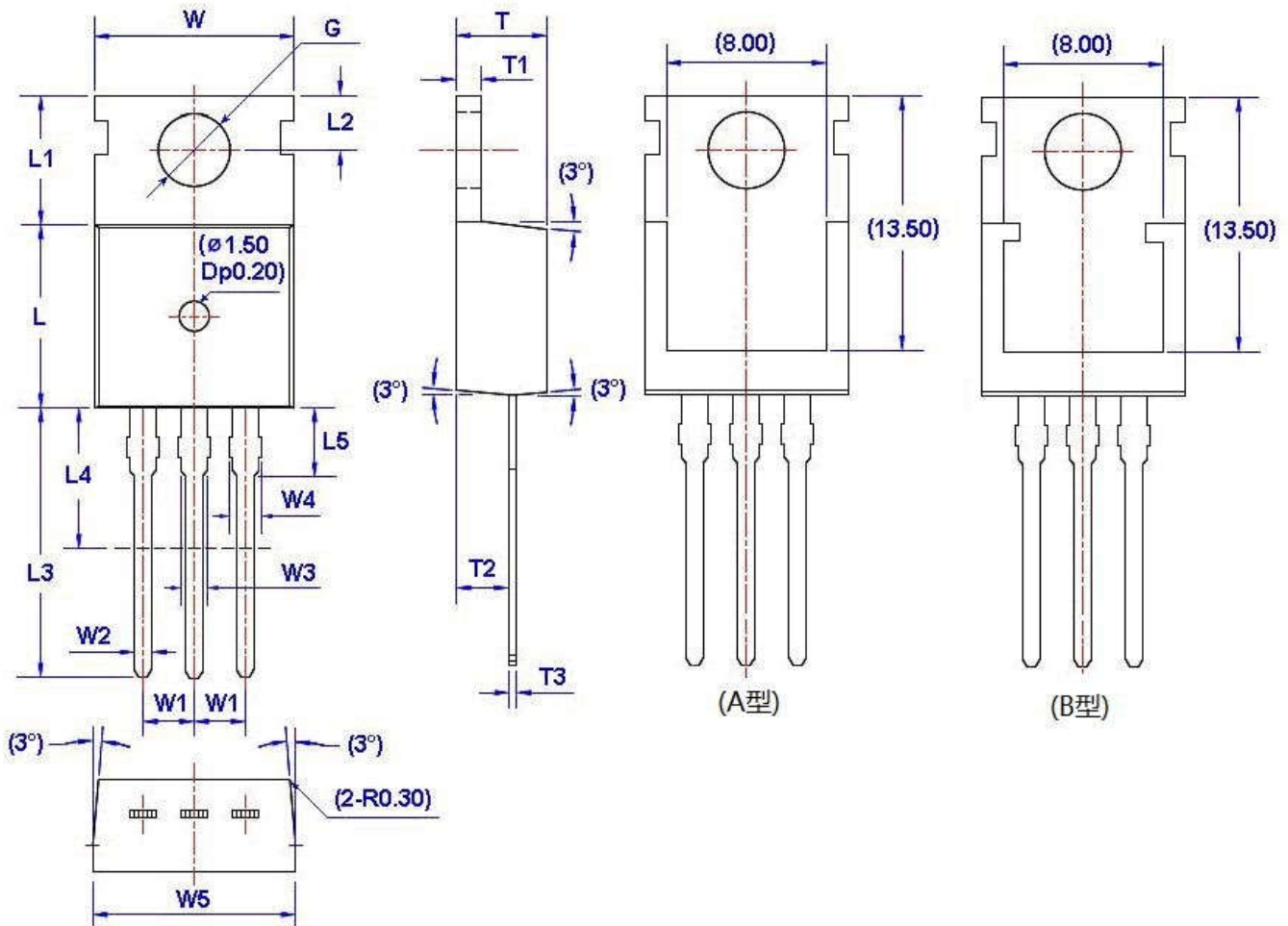

Symbol	Size		Symbol	Size		Symbol	Size		Symbol	Size	
	Min	Max		Min	Max		Min	Max		Min	Max
W	9.66	10.28	W5	9.80	10.20	L4**	6.20	6.60	T3	0.45	0.60
W1	2.54 (TYP)		L	9.00	9.40	L5	2.79	3.30	G(ϕ)	3.50	3.70
W2	0.70	0.95	L1	6.40	6.80	T	4.30	4.70			
W3	1.17	1.37	L2	2.70	2.90	T1	1.15	1.40			
W4*	1.32	1.72	L3	12.70	14.27	T2	2.20	2.60			